



- Features :
  - Universal AC input / Full range (up to 305VAC)
  - Built-in active PFC function
  - Protections: Short circuit / Over current / Over voltage / Over temperature
  - Cooling by free air convection
  - OCP point adjustable through output cable or internal potentiometer
  - IP67 / IP65 design for indoor or outdoor installations
  - Class 2 power unit
  - Three in one dimming function (1~10Vdc or PWM signal or resistance)
  - Suitable for LED lighting and moving sign applications
  - Compliance to worldwide safety regulations for lighting
  - Suitable for dry / damp / wet locations
  - 5 years warranty (Note.10)



HLG-60H-15  Blank : IP67 rated. Cable for I/O connection.  
 A : IP65 rated. Output voltage and constant current level can be adjusted through internal potentiometer.  
 B : IP67 rated. Constant current level adjustable through output cable with 1~10Vdc or 10V PWM signal or resistance.  
 D (option) : IP67 rated. Timer dimming function, contact MEAN WELL for details.

### SPECIFICATION

MODEL	HLG-60H-15 <input type="checkbox"/>	HLG-60H-20 <input type="checkbox"/>	HLG-60H-24 <input type="checkbox"/>	HLG-60H-30 <input type="checkbox"/>	HLG-60H-36 <input type="checkbox"/>	HLG-60H-42 <input type="checkbox"/>	HLG-60H-48 <input type="checkbox"/>	HLG-60H-54 <input type="checkbox"/>		
OUTPUT	DC VOLTAGE	15V	20V	24V	30V	36V	42V	48V	54V	
	CONSTANT CURRENT REGION <small>Note.4</small>	9 ~ 15V	12 ~ 20V	14.4 ~ 24V	18 ~ 30V	21.6 ~ 36V	25.2 ~ 42V	28.8 ~ 48V	32.4 ~ 54V	
	RATED CURRENT	4A	3A	2.5A	2A	1.7A	1.45A	1.3A	1.15A	
	RATED POWER	60W	60W	60W	60W	61.2W	60.9W	62.4W	62.1W	
	RIPPLE & NOISE (max.) <small>Note.2</small>	150mVp-p	150mVp-p	150mVp-p	200mVp-p	200mVp-p	300mVp-p	300mVp-p	300mVp-p	
	VOLTAGE ADJ. RANGE <small>Note.6</small>	13.5 ~ 17V	17 ~ 22V	22 ~ 27V	27 ~ 33V	33 ~ 40V	40 ~ 46V	44 ~ 53V	49 ~ 58V	
	CURRENT ADJ. RANGE	Can be adjusted by internal potentiometer A type only								
		2.4 ~ 4A	1.8 ~ 3A	1.5 ~ 2.5A	1.2 ~ 2A	1 ~ 1.7A	0.87 ~ 1.45A	0.78 ~ 1.3A	0.69 ~ 1.15A	
	VOLTAGE TOLERANCE <small>Note.3</small>	± 2.0%	± 1.0%	± 1.0%	± 1.0%	± 1.0%	± 1.0%	± 1.0%	± 1.0%	
	LINE REGULATION	± 0.5%	± 0.5%	± 0.5%	± 0.5%	± 0.5%	± 0.5%	± 0.5%	± 0.5%	
LOAD REGULATION	± 1.5%	± 1.0%	± 1.0%	± 0.5%	± 0.5%	± 0.5%	± 0.5%	± 0.5%		
SETUP, RISE TIME <small>Note.8</small>	500ms, 80ms at full load 230VAC /115VAC									
HOLD UP TIME (Typ.)	16ms/230VAC 16ms/115VAC at full load									
INPUT	VOLTAGE RANGE <small>Note.5</small>	90 ~ 305VAC		127 ~ 431VDC						
	FREQUENCY RANGE	47 ~ 63Hz								
	POWER FACTOR (Typ.)	PF>0.98/115VAC, PF>0.95/230VAC, PF>0.92/277VAC at full load (Please refer to "Power Factor Characteristic" curve)								
	TOTAL HARMONIC DISTORTION	THD< 20% when output loading ≥ 60% at 115VAC/230VAC input and output loading ≥ 75% at 277VAC input								
	EFFICIENCY (Typ.)	87.5%	89%	89.5%	90%	90%	90%	90.5%	90.5%	
	AC CURRENT (Typ.)	0.64A / 115VAC		0.32A / 230VAC		0.3A / 277VAC				
	INRUSH CURRENT(Typ.)	COLD START 55A(twidth=265μs measured at 50% Ipeak) at 230VAC								
	LEAKAGE CURRENT	<0.75mA / 277VAC								
PROTECTION	OVER CURRENT <small>Note.4</small>	95 ~ 108%								
	SHORT CIRCUIT	Protection type : Constant current limiting, recovers automatically after fault condition is removed								
	OVER VOLTAGE	Hiccup mode, recovers automatically after fault condition is removed								
	OVER TEMPERATURE	18 ~ 24V 23 ~ 30V 28 ~ 35V 35 ~ 43V 41 ~ 49V 48 ~ 58V 54 ~ 65V 59 ~ 68V								
ENVIRONMENT	WORKING TEMP.	Shut down o/p voltage, re-power on to recover								
	WORKING HUMIDITY	Shut down o/p voltage, re-power on to recover								
	STORAGE TEMP., HUMIDITY	-40 ~ +70°C (Refer to "Derating Curve")								
	TEMP. COEFFICIENT	20 ~ 95% RH non-condensing								
	VIBRATION	-40 ~ +80°C, 10 ~ 95% RH								
SAFETY & EMC	SAFETY STANDARDS <small>Note.7</small>	± 0.03%/°C (0 ~ 60°C)								
	WITHSTAND VOLTAGE	10 ~ 500Hz, 5G 12min./1cycle, period for 72min. each along X, Y, Z axes								
	ISOLATION RESISTANCE	UL8750, CSA C22.2 No. 250.0-08 (except for 48V, 54V), EN61347-1, EN61347-2-13 independent, IP65 or IP67, J61347-1, J61347-2-13 approved ; design refer to UL60950-1, TUV EN60950-1, EN60335-1								
	EMC EMISSION	I/P-O/P:3.75KVAC I/P-FG:2KVAC O/P-FG:1.5KVAC								
	EMC IMMUNITY	I/P-O/P, I/P-FG, O/P-FG:100M Ohms / 500VDC / 25°C / 70% RH								
OTHERS	MTBF	Compliance to EN55015, EN61000-3-2 Class C (≥60% load) ; EN61000-3-3								
	DIMENSION	Compliance to EN61000-4-2,3,4,5,6,8,11; EN61547, EN55024, light industry level (surge 4KV), criteria A								
	PACKING	338K hrs min. MIL-HDBK-217F (25°C)								
NOTE	171*61.5*36.8mm (L*W*H)									
	0.73Kg; 20pcs/15.6Kg/0.9CUFT									
	1. All parameters NOT specially mentioned are measured at 230VAC input, rated load and 25°C of ambient temperature. 2. Ripple & noise are measured at 20MHz of bandwidth by using a 12" twisted pair-wire terminated with a 0.1uf & 47uf parallel capacitor. 3. Tolerance : includes set up tolerance, line regulation and load regulation. 4. Please refer to "DRIVING METHODS OF LED MODULE". 5. Derating may be needed under low input voltages. Please check the static characteristics for more details. 6. A type only. 7. Safety and EMC design refer to EN60598-1, CNS15233, GB7000.1, FCC part18. 8. Length of set up time is measured at cold first start. Turning ON/OFF the power supply may lead to increase of the set up time. 9. The power supply is considered as a component that will be operated in combination with final equipment. Since EMC performance will be affected by the complete installation, the final equipment manufacturers must re-qualify EMC Directive on the complete installation again. 10. Refer to warranty statement. 11. To fulfill requirements of the latest ErP regulation for lighting fixtures, this LED power supply can only be used behind a switch without permanently connected to the mains.									

**Mechanical Specification**

Case No.957B Unit:mm

**Blank:(HLG-60H)**

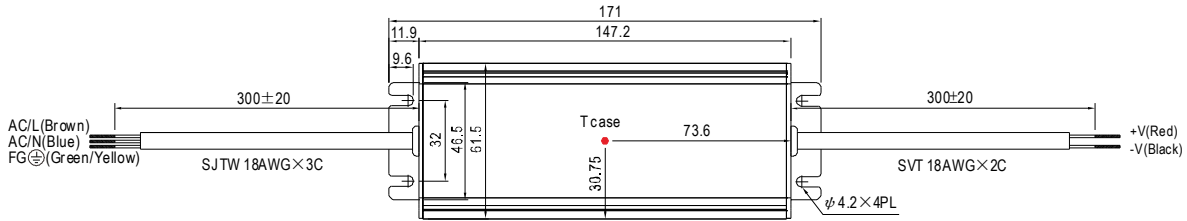

※ T case: Max. Case Temperature.

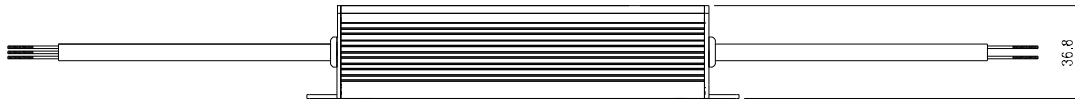

※IP67 rated. Cable for I/O connection.

**A Type:(HLG-60H\_A)**

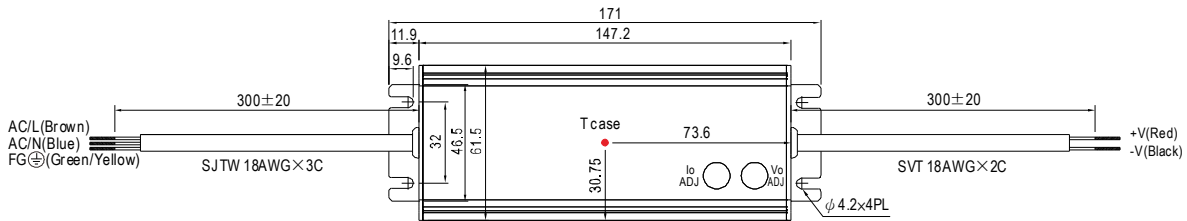

※ T case: Max. Case Temperature.

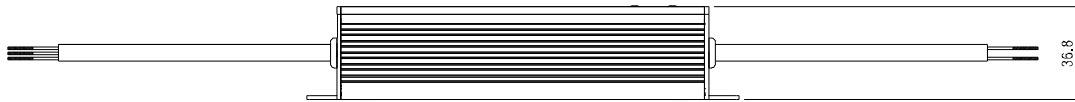

※ IP65 rated. Output voltage and constant current level can be adjusted through internal potentiometer.  
(Can access by removing the rubber stopper on the case.)

**B Type:(HLG-60H\_B)**

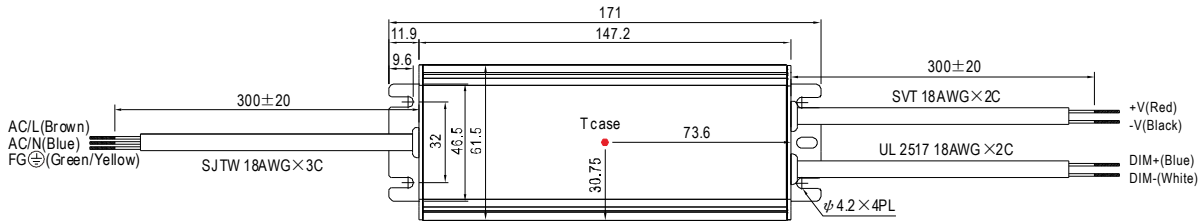

※ T case: Max. Case Temperature.

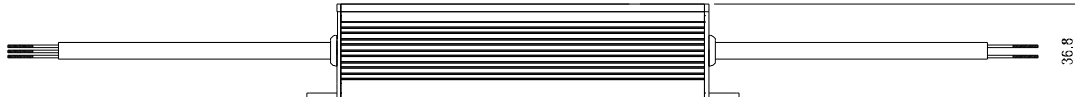

**D Type(option):(HLG-60H-\_D)**

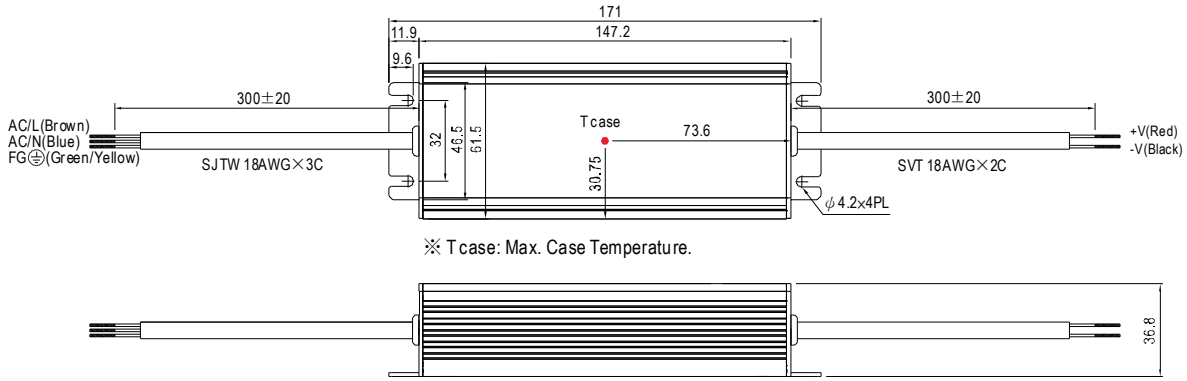

※ IP67 rated. Timer dimming function, contact MEAN WELL for details.

**Block Diagram**

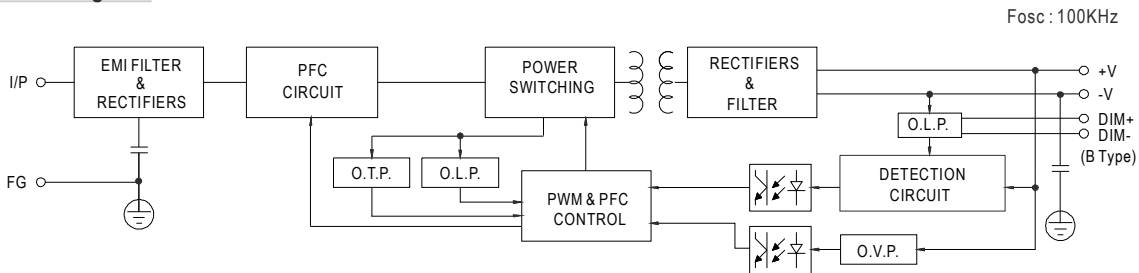

**Derating Curve**

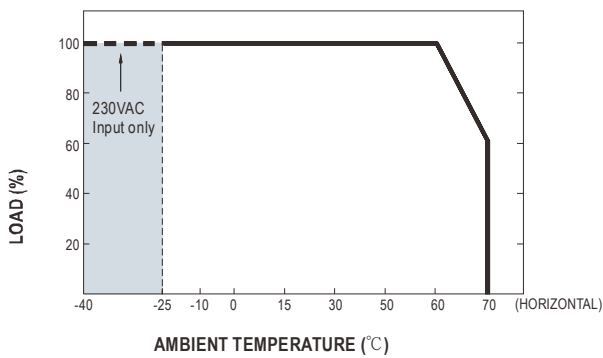

**Static Characteristics**

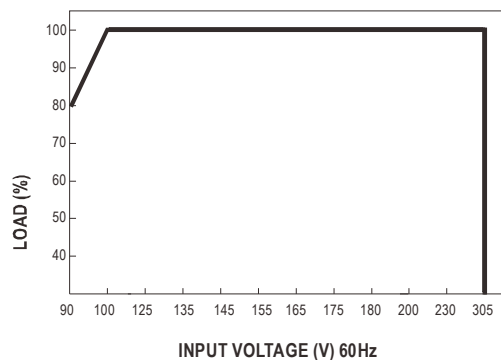

**Power Factor Characteristic**

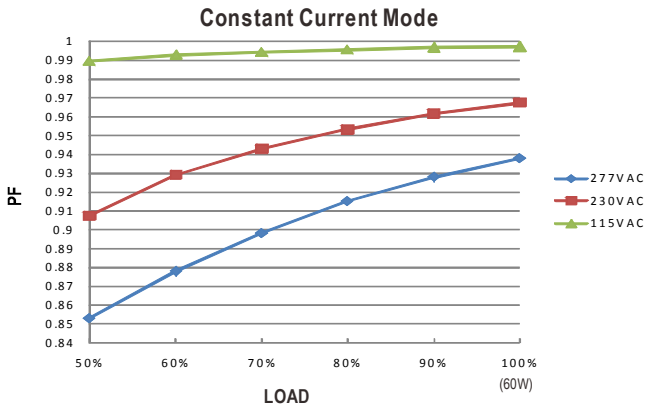

**EFFICIENCY vs LOAD (48V Model)**

HLG-60H series possess superior working efficiency that up to 90.5% can be reached in field applications.

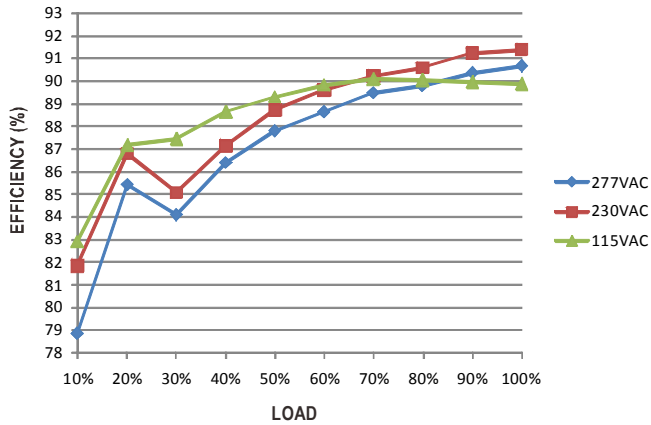

**DRIVING METHODS OF LED MODULE**

There are two major kinds of LED drive method "direct drive" and "with LED driver".  
 A typical LED power supply may either work in "constant voltage mode (CV) or constant current mode (CC)" to drive the LEDs.  
 Mean Well's LED power supply with CV+ CC characteristic can be operated at both CV mode (with LED driver, at area (A) and CC mode (direct drive, at area (B)).

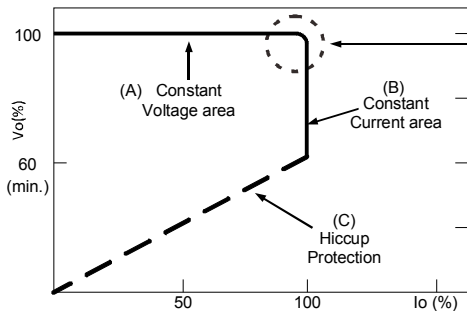

Typical LED power supply I-V curve

In the constant current region, the highest voltage at the output of the driver depends on the configuration of the end systems.  
 Should there be any compatibility issues, please contact MEAN WELL.

**DIMMING OPERATION (for B-type only)**

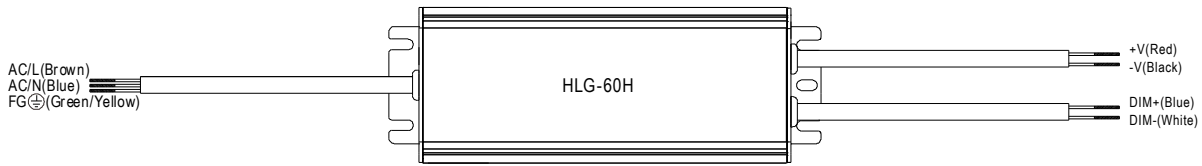

※ Built-in 3 in 1 dimming function, IP67 rated. Output constant current level can be adjusted through output cable by connecting a resistance or 1 ~ 10Vdc or 10V PWM signal between DIM+ and DIM-.

※ Please DO NOT connect "DIM-" to "-V".

※ Reference resistance value for output current adjustment (Typical)

Resistance value	Single driver	10K Ω	20K Ω	30K Ω	40K Ω	50K Ω	60K Ω	70K Ω	80K Ω	90K Ω	100K Ω	OPEN
	Multiple drivers (N=driver quantity for synchronized dimming operation)	10K Ω/N	20K Ω/N	30K Ω/N	40K Ω/N	50K Ω/N	60K Ω/N	70K Ω/N	80K Ω/N	90K Ω/N	100K Ω/N	-----
Percentage of rated current		10%	20%	30%	40%	50%	60%	70%	80%	90%	100%	95%~108%

※ 1 ~ 10V dimming function for output current adjustment (Typical)

Dimming value	1V	2V	3V	4V	5V	6V	7V	8V	9V	10V	OPEN
Percentage of rated current	10%	20%	30%	40%	50%	60%	70%	80%	90%	100%	95%~108%

※ 10V PWM signal for output current adjustment (Typical): Frequency range : 100Hz ~ 3KHz

Duty value	10%	20%	30%	40%	50%	60%	70%	80%	90%	100%	OPEN
Percentage of rated current	10%	20%	30%	40%	50%	60%	70%	80%	90%	100%	95%~108%

※ Using the built-in dimming function on B-type model can't turn the lighting fixture totally dark. Please refer to the connection method below to achieve 0% brightness of the lighting fixture connecting to the LED power supply unit.

※ Direct connecting to LEDs is suggested, but is not suitable for using additional drivers.

Dimming connection diagram for turning the lighting fixture ON/OFF :

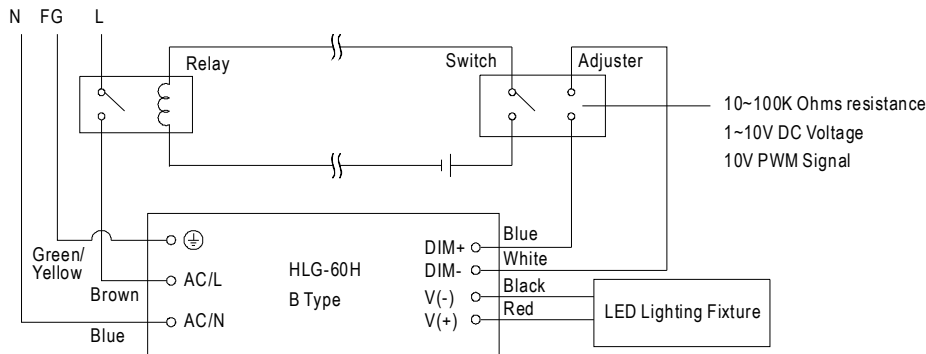

Using a switch and relay can turn ON/OFF the lighting fixture.

1. Output constant current level can be adjusted through output cable by connecting a resistance or 1~10Vdc or 10V PWM signal between DIM+ and DIM-.
2. The LED lighting fixture can be turned ON/OFF by the switch.

**WATERPROOF CONNECTION**

◎ Waterproof connector

Waterproof connector can be assembled on the output cable of HLG-60H to operate in dry/wet/damp or outdoor environment.

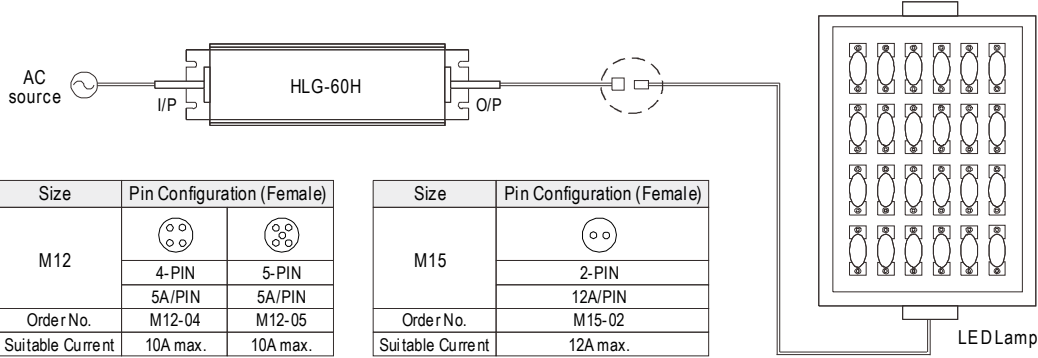

◎ Cable Joiner

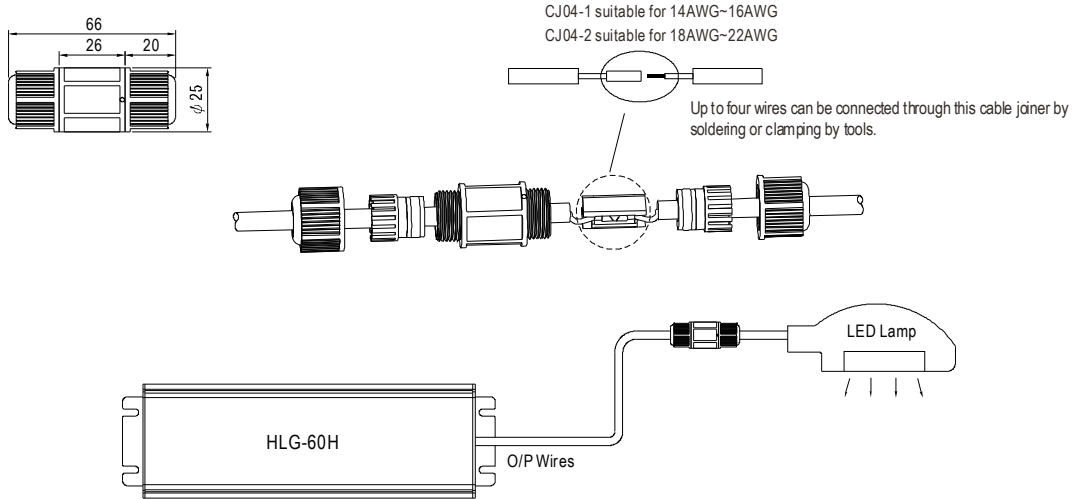

※CJ04 cable joiner can be purchased independently for user's own assembly.  
MEAN WELL order No. : CJ04-1, CJ04-2.